

Eachine Flyingfrog Q90



www.eachine.com



INSTRUCTION MANUAL

14+ AGES

Eachine Flyingfrog Q90



ALL FUN IN YOUR HAND

Table of Contents

1.0 Know Your Airplane	2
2.0 Parameters	3
2.1 Features	4
2.2 F3 6DOF flight control port definition diagram	5
3.0 Flight precaution	6
4.0 Assembly of aircraft	7
4.1 Install the blades	7
4.2 Install the battery	7
4.3 Aircraft center of gravity adjustment method	7
5.0 Ready to fly	8
5.1 Turn on the aircraft	8
5.2 Motor unlocked/locked	8
6.0 End of Flight	9
7.0 Annex 1	10
7.1 Annex 2	11
7.2 Annex 3	12

1.0 Know Your Airplane

Structure using ABS material, the new industrial and modular design, improved product development, ease of installation and maintenance, replacement upgrades, etc., equipped with 5.8G real-time map system, to give you a different visual effects.

- 1.Forward motor
- 2.Reverse the motor
- 3.Forward propeller
- 4.Reverse the propeller
- 5.Camera
- 6.Flight control
- 7.Receiver
- 8.Figure transmission
- 9. Aircraft cover
- 10. Under the plane
- 11.Battery
- 12.Rubber band

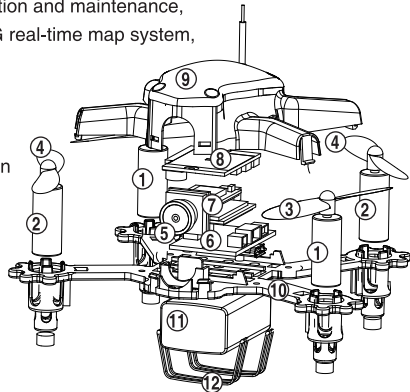

2.0 Parameters

Specification of the drone

Main wing length: 55mm  
 Size (length x width x height): 88 x 58 x 40mm  
 Weight: 43g (without battery)  
 Flight control: F3 6DOF  
 Motor: 8520 2S brush motor  
 Battery: 7.4V 350mAh  
 Flight time: 8 minutes  
 Working environment temperature: -10 °C to +40 °C

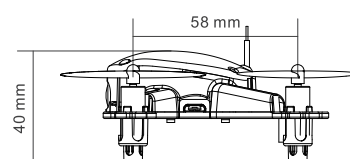
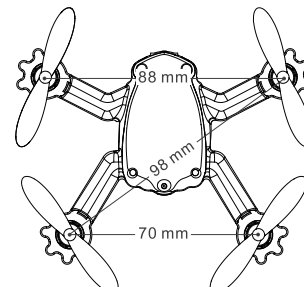

2.1 Features

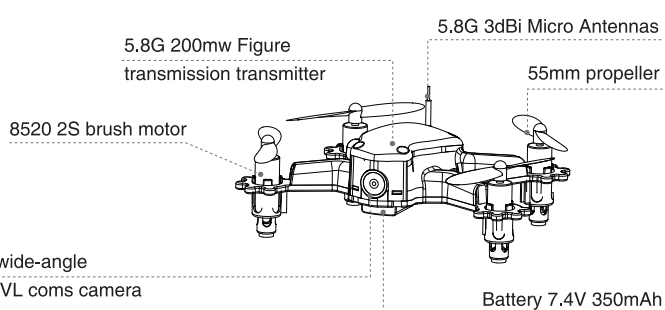

2.2 F3 6DOF flight control port definition diagram

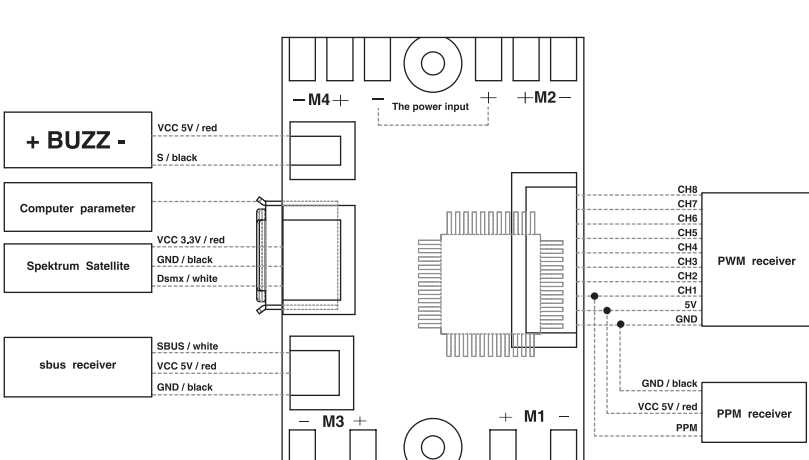

3.0 Flight precautions

- The plane is applicable to the people with operating experience,not younger than 14.
- Do not fly in wicked weather condition,such as gale,raining,snowing,fog and so on.
- Chose open and legal flying field.
- Pls stay away from the high speed rotating parts(such as propellers,brushless motor).
- Pls do not fly in the field with high tension line,base station or launch tower,in case of interference on RC controller.
- Pls do not fly in the no-fly zone limited by law and rules.

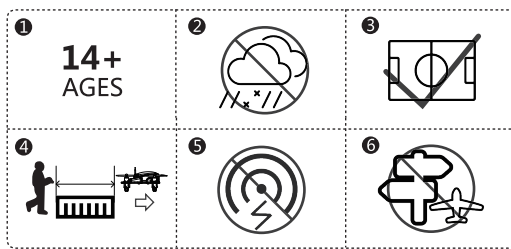

4.0 Assembly of aircraft

4.1 Install the blades

Install the forward propeller on the forward motor as the arrow direction show,install the reversed propeller on the reversed motor as the arrow direction show,screw the propellers to tighten by hand,make sure the propellers installing correctly and solidly.

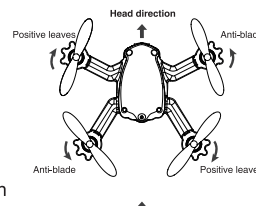

4.2 Installing battery

The rubber band fixed battery in the bottom of the aircraft, adjust the center of gravity of the aircraft, the head and tail basic level.

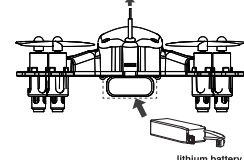

4.3 Aircraft center of gravity adjustment method

Hang the drone in the air based on the fulcrum of the gravity center,if the head drop down,means the center is in front,please backward the battery;if the tail drop down,means the center is in back,please forward the battery,till to the make the head and tail horizontal.

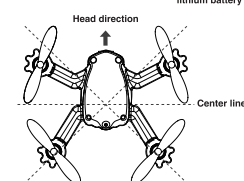

5.0 Ready to fly

5.1 Turn on the aircraft

Make the drone stayed horizontal,connect the power of the drone.

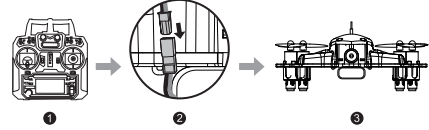

Notice:

Erect the receiving antennas before flying,to increase the distance of communication.

Notice: Choose a open field with soft land to fly.

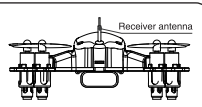

5.2 Motor unlocked/locked

**Motor unlocked**  
Put the throttle stick to the lowest point,turn the direction of the joystick to the right--the motor is unlocked.

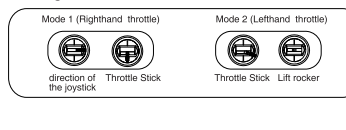

**Motor locked**  
Put the throttle stick to the lowest point,turn the direction of the joystick to the left--the motor is locked.

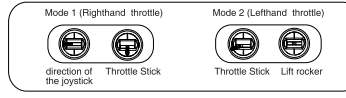

6.0 End of Flight

- Landing by hand.
- Close the power of the plane,then close the power of the rc controller.
- Take out the battery from the plane.

Notice

- Crossing fly is more applicable for the operator with experience.
- When crossing flying,please flying in the sight of 50m or in the range of 300m with video receiving(the actual range is depended on the weather condition and flying environment).
- When crossing please avoid the obstacle such as crowd,animals and high tension line and so on.

Crossing fly

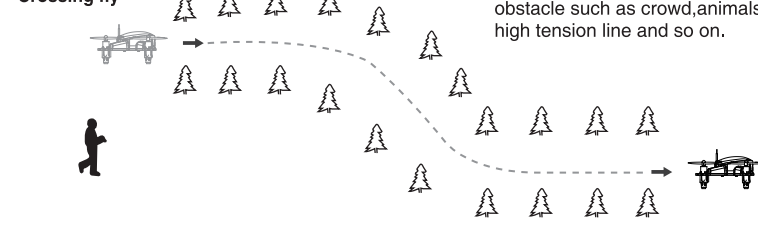

7.0 Annex 1

DSM2 Receiver specification

- Compatible with DSM2 -DSMX transmitters or modules
- Output S-BUS or CPPM
- Designed for indoor FPV pocket drones from 80mm-110mm size such as inductrix
- Super light: only 0.8g

**Specification:**  
 Working voltage: 3.7V-5.5V  
 Size: 17 x 13 x 5 mm  
 Weight: 0.8 g  
 Binding to SBUS/PPM code: default mode is Sbus mode

- SBUS mode: Turn off your transmitter, power on the receiver, about 6 seconds later, when the LED on the receiver flash rapidly, the receiver is ready for binding, then turn on the transmitter, then enter the binding mode, the led on the receiver will be light on.
- PPM mode: Turn off the transmitter, power up the receiver, wait for 30 seconds, turn on the transmitter, now the receiver is bound to the transmitter, the led on the receiver will flash 1 time each 10 seconds.

**LED instructions:**  
 High-speed LED flashing, means ready for binding LED out, means no signal.  
 LED on, everything is fine and is in SBUS mode.  
 LED on: About 10 seconds flash one time, means it is in PPM mode and works fine.

7.1 Annex 2

Frsky Receiver specification

- Compatible with Frsky D8 transmitter X9D and X12S and D-mode modules.
- Output Sbus or PPM
- Designed for indoor FPV quadcopter from 80mm-110mm like horizonhobby inductrix
- Super light: only 0.8g

**Specification:**  
 Working voltage: 3.7V-5.5V  
 Size: 17 x 13 x 5 mm  
 Weight: 0.8 g  
 Binding to SBUS/PPM code: default mode is Sbus mode

- SBUS mode: Turn off your transmitter, power on the receiver, about 6 seconds later, when the LED on the receiver flash rapidly, the receiver is ready for binding,then turn on the transmitter, then enter the binding mode, the led on the receiver will be light on.
- Convert CPPM mode:turn off the transmitter, power up the receiver, wait for 30 seconds, turn on the transmitter, now the receiver is ready for binding, after the receiver is bound to the transmitter, the led on the receiver will flash 1 time each 10 second.

**LED instructions:**  
 High-speed LED flashing, means ready for binding LED out, means no signal.  
 LED on, everything is fine and is in SBUS mode.  
 Led's on: about 10 seconds flash one time, means it is in PPM mode and works fine.

7.2 Annex 3

Flysky Receiver specification

- Signal output: PPM  
 Antenna length: 30MM  
 Supply voltage: 5.0V  
 Overall dimensions: 11.5 x 24 x 0.6mm  
 Weight: 0.8 g

The code method:

- He remote control above all the SW switch up.
- Simultaneously turn the aileron trim switch and heading trimmer switch on and turn on the remote control power switch.
- Press OK key to enter remote control setup interface, enter SYSTEM, set AFHDS 2A in RX setup to OFF, then press Cancel to save and exit.
- Enter the AUX channels interface in the remote control setup. Set CH5 to SWC, CH6 to SWB and then press cancel to save and exit.
- To the receiving end (aircraft) power, this time the receiver on the code above the indicator light flash.
- Immediately press the remote control on the code above the key, and open the remote control power, this time to enter the code state, the remote control shows RXBINDing, the receiver on the code above the indicator light.
- the remote control power and then power, then the receiver on the code is successful, the light is highlighted.